



GASTON GT

range is the most common standard and the first generation delicate product which is designed with AGM(Absorbent Glass Mat) technology, high performance plates and electrolyte. The definition of GT is coming from General purpose. Therefore, this range product has possessed various applications for common power backup system.

Applications

- | | |
|---------------------------|--|
| Alarm System | Medical Equipment |
| Cable Television | UPS |
| Communication Equipment | Power Tool |
| Control Equipment | Emergency Power System |
| Security System | Stand-by Electric Power Control System |
| Emergency Lighting System | |

General Features

- Sealed and maintenance free operation.
- Non-Spillable construction design.
- ABS containers and covers(UL94HB, UL94V-0) optional.
- Safety valve installation for explosion proof.
- High quality and high reliability.
- Exceptional deep discharge recovery performance.
- Low self discharge characteristic.
- Flexibility design for multiple install positions.

Construction

- | | | | |
|-----------|-------------------|--------------|--------------------|
| Component |Raw material | Sealant |Epoxy Resin |
| Positive |Lead dioxide | Safety valve |EPDR |
| Negative |Lead | Terminal |Copper |
| Container |ABS | Separator |Fiber glass |
| Cover |ABS | Electrolyte |Sulfuric acid |

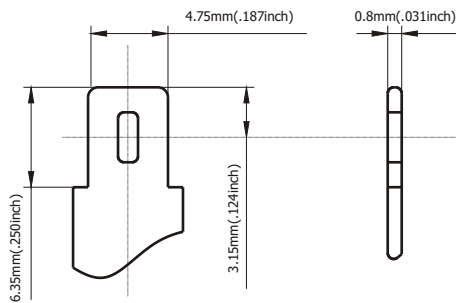

Terminal Dimensions

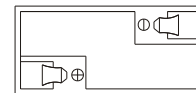
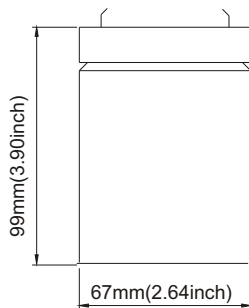

Battery Model	GT 6-2.8			
Designed Floating Life	5 Years			
Capacity(25°C)	20HR(0.14A,1.75V)	10HR(0.26A,1.75V)	5HR(0.48A,1.75V)	1HR(1.82A,1.75V)
	2.8Ah	2.6Ah	2.40Ah	1.82Ah
Dimensions	Length	Width	Height	Total Height
	67mm(2.64inch)	34mm(1.34inch)	99mm(3.9inch)	106mm(4.17inch)
Approx. Weight	0.61Kg (1.34 lbs)			
Internal Resistance	Full charged at 25°C :0.034 Ohm			
Self Discharge	3% of capacity declined per month at (25°C)			
Capacity Affected by Temp.(20HR)	40°C	25°C	0°C	-15°C
	102%	100%	85%	65%
Charge Voltage(25°C)	Cycle use		Float use	
	7.2-7.5V(-15mV/ °C), max. Current: 0.84A		6.8-6.9V(-10mV/ °C)	

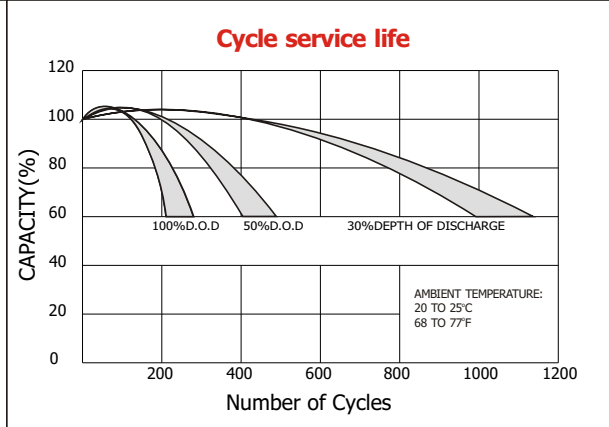
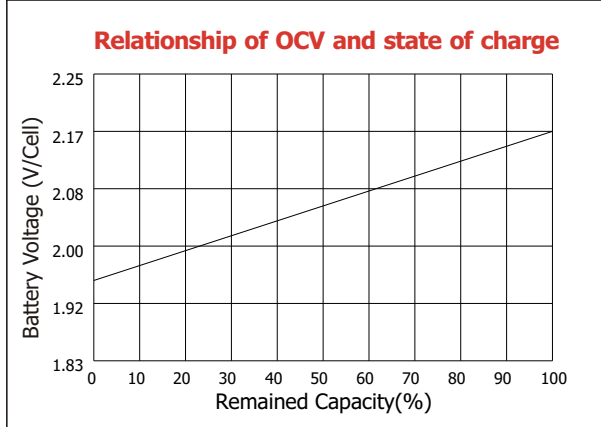
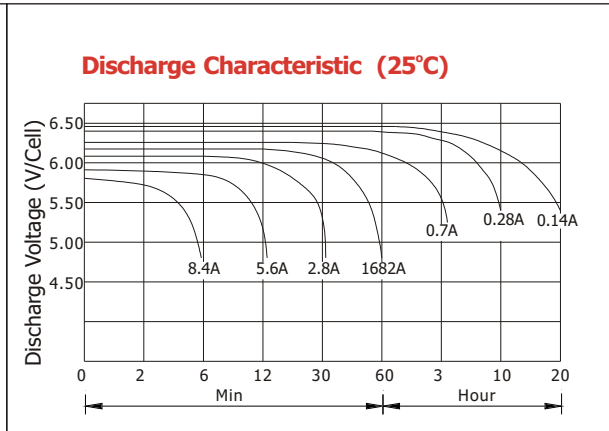
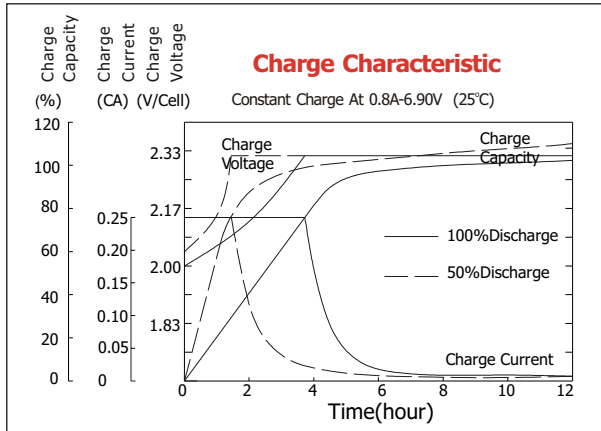

Constant current discharge ratings-amperes at 25°C

F.V/Time	5MIN	10MIN	15MIN	30MIN	1HR	3HR	5HR	10HR	20HR
1.60V	10.9	6.81	5.13	3.13	1.99	0.87	0.53	0.29	0.16
1.67V	10.3	6.46	4.94	2.99	1.96	0.84	0.52	0.29	0.15
1.70V	9.41	6.22	4.82	2.72	1.90	0.78	0.51	0.28	0.15
1.75V	9.22	6.03	4.67	2.59	1.81	0.76	0.50	0.28	0.15
1.80V	8.25	5.76	4.24	2.40	1.70	0.73	0.47	0.28	0.14
1.85V	7.28	5.48	3.81	2.21	1.58	0.70	0.44	0.27	0.14

Constant power discharge ratings-watts at 25°C

F.V/Time	5MIN	10MIN	15MIN	30MIN	1HR	3HR	5HR	10HR	20HR
1.60V	19.2	12.29	9.37	5.64	3.59	1.55	0.90	0.60	0.31
1.67V	18.5	11.98	9.26	5.52	3.57	1.50	0.90	0.59	0.30
1.70V	17.4	11.86	9.18	5.17	3.50	1.43	0.89	0.59	0.30
1.75V	17.5	11.82	9.10	5.02	3.44	1.40	0.88	0.58	0.29
1.80V	16.1	11.65	8.44	4.78	3.24	1.36	0.85	0.57	0.28
1.85V	14.6	11.05	7.65	4.48	3.05	1.32	0.82	0.57	0.27

